

RECKE

— Quality First —

MULTICOOKER

MC - X170

5L 860w



USER MANUAL

RECKE INDUSTRIES LIMITED
www.myrecke.com

TABLE OF CONTENTS

Introduction	5
Important safety information.....	7
Getting started.....	9
Features and technical specifications.....	10
•Accessories.....	11
•Technical specifications.....	11
•Control panel display.....	12
Operating Instructions.....	13
•Setting the cooking time.....	13
•Setting the cooking temperature.....	14
•Delayed start.....	14
•Maintaining the temperature of ready-made meals (auto-heat).....	15
•Warming	15
•Child lock	16
•Sound control.....	16
Automatic cooking programs	17
•Summary table of cooking programs.....	17
•PRO.....	19
•Steam.....	20
•Baby food	21
•Fry.....	22
•Boil.....	23
•Grain.....	24
•Pilaf	25
•Pasta	26
•Milk porridge.....	27
•Cake	28
•Bread.....	29
•Pizza.....	30
•Slow cook.....	31
•Yogurt.....	32
•Soup.....	33
•Game.....	34
•Stew	35
•Curd	36
•Dessert.....	37
•Deep fry.....	38

•Additional features	39
-Sterilization.....	39
Multicooker maintenance.....	40
•Handling and care instructions.....	40
•Cleaning the body of the appliance	40
•Cleaning the bowl	40
•Cleaning the steam valve	40
•Condensate removal.....	40
Before applying to the Service Centre.....	41
Warranty Terms.....	42

INTRODUCTION

Dear Customer,

Thank you for choosing RECKE product.

RECKE is the brand focused on high standards of quality, reliability, and modern design with continuous customer care in mind.

We hope that you will enjoy using RECKE MC-X170 multicooker and consider purchasing other products offered by RECKE.

For proper handling and care of the RECKE cooker, we recommend reading this User Manual, which contains important operating, safety, and maintenance instructions.

For any further information about RECKE and its products, please visit our website:

www.myrecke.com

Multicooker is a worth buying innovation, which will let you and your family not only consume tasty food but highly nutritious at the same time.

It is no secret that our usual cooking process destroys most of the vitamins contained in the products. Multicooker helps to avoid this.

The architecture of this appliance allows you to cook free of oil and fat, thereby saving healthy ingredients of the products; moreover, the food cooked in its own juices preserves its natural taste. Airtight sealed lid prevents products from oxidizing, while they are being cooked, implying there is no loss of useful vitamins and minerals.

Multicooker with a ceramic bowl has several advantages, with one of the most compelling ones being environmentally friendly, non-stick and heat resistance features. If the ceramic coating is heated to a high temperature or damaged, it will not lead to any harmful emanations, since the components of the coating are based on liquid material.

Multicooker is an invaluable appliance for a person leading a healthy lifestyle.

The RECKE multicooker is a modern multi-functional device allowing you to cook your favorite food quickly and safely. With the help of the RECKE multicooker you are now able to boil, fry, bake, stew as well as cook soup, any porridge and pilaf, make desserts and many other things fast, tasty, and healthy.

Simply put all the necessary ingredients into the multicooker, select the required automatic program, press the "Start" button, and the cooking process will start automatically. Spend your spare time with the loved-ones and, in the meantime, let the RECKE multicooker cook your favorite dish.

We managed to combine the best cooking techniques in one cooker, so that you are able to prepare healthy and wholesome food and spend less time in the kitchen. From now on, you will have an abundant table of dishes you have never had an opportunity to cook.

While cooking strong smelling products (for example, some types of fish), there is almost no spread of odor. Meat cooked in the cooker is tenderized. More vitamins and other nutrients are preserved, including the natural color of vegetables.

By installing the steam container inside the RECKE multicooker, it is possible to cook steamed food, with the possibility to adjust the cooking time. As a result, the RECKE multicooker is transformed into the steam cooker.

By using the "Sterilization" function, one can sterilize kitchen ware, dishes (jars, spoons, forks), baby bottles, and other small items in the RECKE multicooker.

Do you want to improve your digestion and the immune system? Nothing could be easier – just include yogurt in your daily diet. This fermented milk product, known to humans for hundreds of years, contains many useful nutrients. Yogurt improves digestion and helps the body to cope with infections. Now, it is possible to make yogurt at home. With the RECKE multicooker, you can cook delicious and, most importantly, healthy yogurt. You may use special yogurt jars for making a yogurt, included as part of your multicooker accessories.

The inner surface of the inner bowl is covered with a special super strong and scratch-resistant 2-layer Greblon (Germany) ceramic coating. Now you can cook food in its own juices with minimal amount of oil.

The RECKE multicooker allows you to prepare a wide variety of meals, to an astonishment of your family and friends. Our little gift – a book of recipes designed especially for you by the best chefs – will be your best companion for delicious cooking. All the recipes therein have been developed for and tested on the RECKE multicooker!

IMPORTANT SAFETY INFORMATION



IMPORTANT NOTE!

Follow the instructions below to avoid injuring yourself or others as well as damaging personal property.

- This appliance is intended to be used in household and similar applications such as:
 - staff kitchen areas in shops, offices and other working environments;
 - farm houses;
 - by clients in hotels, motels and other residential type environments;
 - bed and breakfast type environments.
- Appliance to be used in accordance with its intended purpose. Any other use, especially misuse, can lead to potential injuries.
- This appliance can be used by children aged from 8 years and above and persons with reduced physical, sensory or mental capabilities or lack of experience and knowledge if they have been given supervision or instruction concerning use of the appliance in a safe way and understand the hazards involved.
- Children shall not play with the appliance.
- Cleaning and user maintenance shall not be made by children without supervision.
- Follow all the safety precautions when using the appliance.
- Multicooker heating element surface is subject to residual heat after use. Do not touch heating element immediately after cooking. Allow the appliance to cool first.
- The multicooker needs to be cleaned regularly after each subsequent use in accordance with Cleaning Instructions, please refer to “**Cleaning and Maintenance**” chapter.
- Please keep electrical connectors of the multicooker away from humidity and liquids, as it may cause malfunction and user can receive a severe electric shock.
- Improper handling may damage the appliance and injure the user.
- If the power cord is damaged, it must be replaced in order to avoid any hazard.
- Never operate a damaged appliance or appliance with a damaged cord/plug. Do not connect the cord to the damaged wall outlet.
- Never plug/unplug the appliance to/from the socket if your hands are wet, do not touch the control panel and buttons with wet hands to avoid electrical shock.
- Never immerse the appliance or the cord in water or any other liquid. Never place them in close proximity to hot surfaces.

- Never insert metal or other foreign objects into outlets.
- Regularly wipe dirt from the plug with a clean and dry cloth to prevent the risk of fire.
- Never turn off the appliance by pulling the power cord. To disconnect the appliance from the wall outlet, grasp the plug, not the cord.
- Always keep your face and hands away from the steam valve during and after cooking.
- Maintenance procedures must be carried out only at authorized service centers.
- Always use the accessories included with this appliance. The use of third-party accessories may damage the appliance and void the warranty.
- Do not cover the lid with a cloth or other objects during the operation.
- Always ensure that the heating element and the bottom of inner bowl are clean and dry.
- Do not leave the ladle or other objects in the bowl.
- After cooking with spices and seasonings, clean the bowl immediately (allow the accessories to cool, beforehand).
- Do not use the bowl as a mixing vessel.
- Do not use metal objects that can scratch the bowl or cause cracks in the ceramic inner coating.
- Clean the inner bowl with a soft cloth only.
- Do not use vinegar in the bowl as it may damage the inner coating.
- Before cooking, fill the inner bowl up to $\frac{4}{5}$ and no less than $\frac{1}{5}$ of its maximum capacity (refer to the figure below).

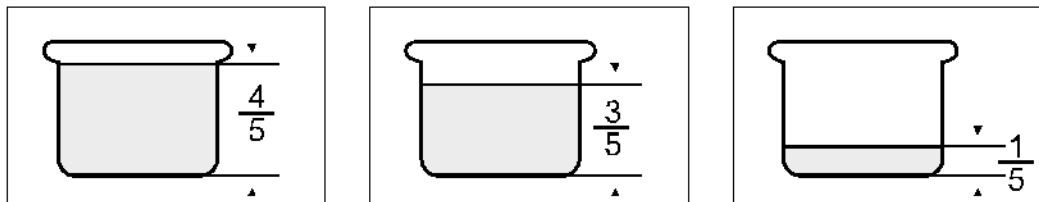

GETTING STARTED

- Please, remove all the packaging accessories.
- Before plugging the appliance into the wall socket, make sure that the voltage indicated on the appliance corresponds to the voltage of your network.
- Firmly plug the power cord into the wall socket.
- Place the cooker on a hard, leveled surface in a ventilated area and away from direct sunlight.
- Before use, make sure that the inner and outer parts of the cooker are not damaged, chipped, or defected. There should be no foreign objects in between the bowl and the heating element.
- Thoroughly rinse the bowl, measuring cup, spoon, steam container, yogurt jars, removable inner part of the lid, and the steam valve with warm water and detergent. Dry thoroughly. Do not use any abrasive cleaners.
- Wipe the body of the appliance with a damp soft cloth.

NOTE! During the first use, there might be a distinctive smell. This is not an indication of a malfunction. The smell is associated with the parts' and the heating element's lubricant being heated.

FEATURES AND TECHNICAL SPECIFICATIONS

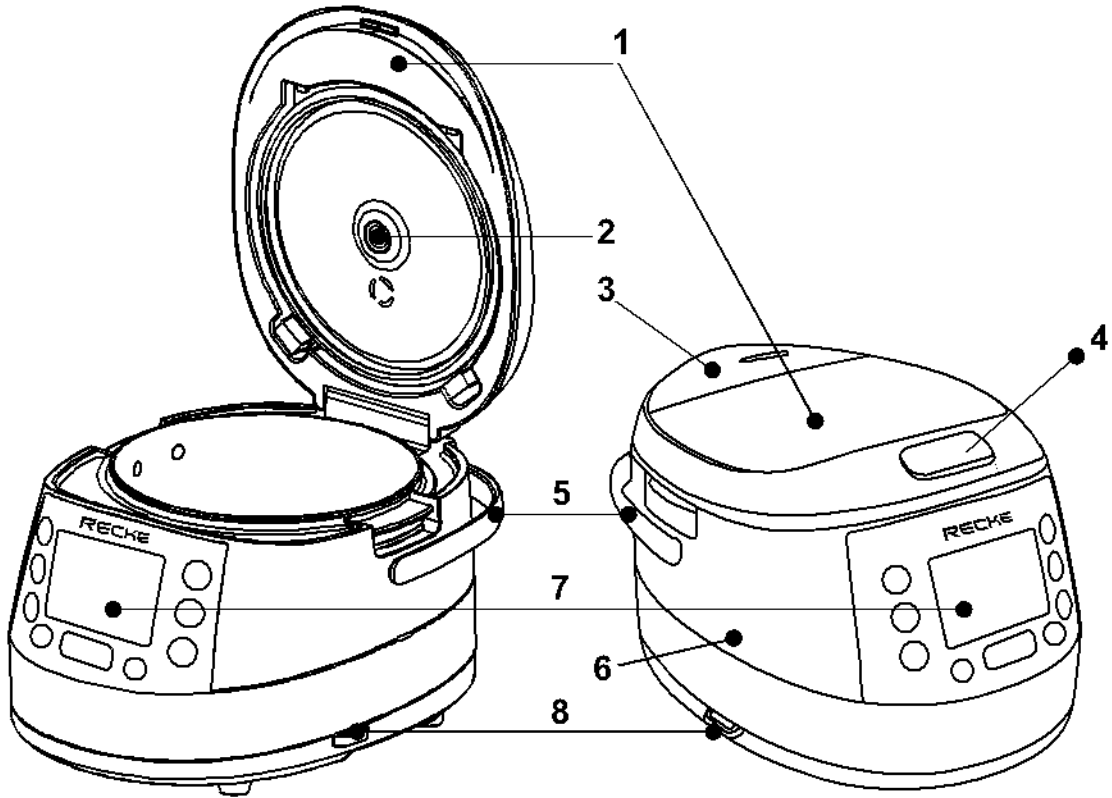

- 1. Lid
- 2. Steam vent
- 3. Removable steam valve
- 4. Button to open the lid
- 5. Handle
- 6. Body
- 7. LCD display and control panel
- 8. Heating element

ACCESSORIES

Multicooker with installed inside bowl	1 unit
Steam container	1 unit
Spoon	1 unit
Ladle	1 unit
Measuring cup	1 unit
Yogurt jars	6 units
Power cord	1 unit
User manual	1 unit
Recipe book	1 unit
Warranty book	1 unit

TECHNICAL SPECIFICATIONS

Model	MC-X170
Programs	20 automatic programs, 49 manual programs
Power	860 Watt
Voltage	220-240 V, 50 Hz
Volume of inner bowl	5 L
Inner bowl coating	Greblon (Germany) – non-stick ceramic coating
Max. heating temperature	180°C
Overheat protection	Available
Removable steam valve	Available
Energy efficiency index/thermo efficiency	Level 2 / 83%

CONTROL PANEL DISPLAY

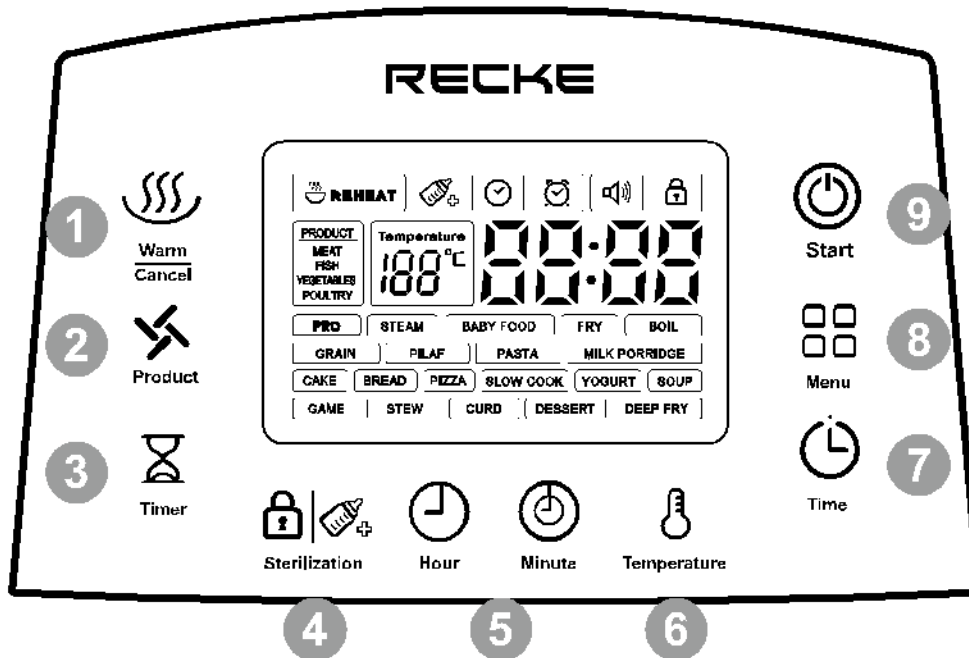



1. The **“Warm/Cancel”** button lets you activate the warming mode; also, it allows you to cancel the selected cooking program, settings and the auto-heat mode.
2. The **“Product selection”** button lets you select the product for cooking (meat, fish, vegetables, poultry) in certain cooking programs.
3. The **“Timer”** button is designed to select the delayed start cooking mode.
4. The **“Sterilization”** button lets you sterilize various small items: kitchen ware, baby bottles, etc. When the cooker is in “standby” mode, by pressing and holding this button, one can activate **“Child lock”** function and block the control panel for the safety of children. As a result, all the control panel buttons will be locked and will not work.
5. The **“Hour”** and the **“Minute”** buttons allow to set the cooking time and temperature.
6. The **“Temperature”** button allows to adjust default temperature settings.
7. The **“Time”** button lets you set the actual time on the LCD display in 24-hour format. It also allows you to adjust the default cooking time for each cooking program.
8. The **“Menu”** button is designed to select the required cooking program.
9. The **“Start”** button allows you to launch the cooking program.

OPERATING INSTRUCTIONS







SETTING THE COOKING TIME

In order to set the actual time on the RECKE MC-X170 multicooker:

Switch on the appliance. Press and hold the **“Hour”**  button for 3 seconds. When the hour indicator starts blinking, set the required time (in hours). Next, to set the time in minutes, press and hold the **“Minute”**  button for 3 seconds and set the required time (in minutes). To save the settings press and hold the **“Hour”** and the **“Minute”** buttons at the same time for few seconds.

The RECKE multicooker is designed such that it is possible to alter the default cooking time for cooking programs. The increment step and available time range for time setting depend on the selected cooking program. It is possible to change the cooking time both before and during the cooking process. To change the cooking time, follow these steps:

Follow the instructions below to change the cooking time:







1. By pressing the **“Menu”**  button, select the required cooking program. If necessary, select the cooking product. The default cooking time for each program will be displayed on the screen.
2. Launch a cooking program by holding the **“Start”**  button for 3 seconds.
3. Press the **“Time”**  button. When the time indicator starts blinking on the LCD display, press the **“Hour”**  and the **“Minute”**  buttons to set the required time in hours and minutes, respectively.
4. To save the cooking time settings, press the **“Time”**  button.



WARNING! When changing the cooking time, take into account available time change range and increment step for each cooking program as indicated in the *Summary table of cooking programs*.

SETTING THE COOKING TEMPERATURE

This function is available for all the cooking programs. It is possible to change the cooking temperature both before and during the cooking process.







1. By pressing the “Menu”  button, select the required cooking program. If necessary, select the cooking product. The default cooking time for each mode will be displayed on the screen.
2. Launch a cooking program by holding the “Start”  button for 3 seconds.
3. Press the “Temperature”  button. When the temperature indicator starts blinking on the LCD display, press the “Hour”  button to decrease and the “Minute”  button to increase the temperature value.
4. To save the cooking temperature settings, press the “Temperature”  button.

DELAYED START

This function allows you to set the time, by which you would want to have a ready meal (within 24 hours). For example, it is 15-00 now and you would like to have your meal ready by 19-00. On this occasion, you will have to set the timer to 19-00. Delayed cooking option is available for all the cooking modes, except for the “Pasta” and the “Fry” programs.



TIP: The “Timer” function is not recommended when perishable foods (eggs, fresh milk, meat, cheese, etc) are to be prepared.

To launch this function, follow these steps:

1. By pressing the “Menu”  button, select the required cooking program. If necessary, select the cooking product.
2. Press the “Timer”  button. The corresponding indicator will appear  on the display and the time indicator will start blinking 00:00.
3. Press the “Hour”  and the “Minute”  buttons to set the required time in hours and minutes, respectively.
4. To launch a program, press and hold the “Start”  button for 3 seconds.

MAINTAINING THE TEMPERATURE OF READY-MADE MEALS (auto-heat)

This function activates automatically at the end of the cooking process (except for the “Yogurt” program) and keeps ready meal warm (70°C) for 24 hours. The “Reheat”  indicator will appear on the display. LCD screen backlight turns green in auto-heat mode.

If necessary, auto-heat mode can be cancelled by pressing the “Cancel”  button. Reheat  indicator will disappear from the display.

DO NOT leave the cooked meal in the auto-heat mode for too long, as it may lead to drying out.

WARMING





If none of the cooking program is activated, the “Warm”  button will activate the warming

function allowing you to keep a ready meal warm at 90°C and for 30 minutes. The “Reheat”  indicator will be displayed on the screen.

If necessary, the “Warm” mode can be cancelled by pressing the “Cancel”  button.





CHILD LOCK

In order to keep the children safe and away from the multicooker, it is possible to block the control panel in the following way:

When the multicooker is in standby mode, press and hold the “**Sterilization**”  button for 3 seconds and the corresponding indicator  will appear on the display. To deactivate this function, press and hold the “**Sterilization**”  button for 3 seconds and the corresponding  indicator will disappear from the display.

SOUND CONTROL

It is possible to set the level of the audible tone in this multicooker (adjusting the volume). To make the adjustments, do the following:

- press and hold the “**Timer**”  button for 3 seconds, the tone indicator  will appear on the display.
- by pressing the “**Hour**”  and the “**Minute**”  buttons, you are able to adjust the volume as necessary (each time you press the “**Hour**” button, the volume will adjust downward, while the “**Minute**” button will adjust the volume upwards).

AUTOMATIC COOKING PROGRAMS

SUMMARY TABLE OF COOKING PROGRAMS

Program	Default cooking time	Cooking time range/increment step	Default cooking temperature	Cooking temperature range/increment step	Product selection/cooking time				Timer	Auto-heat
					Meat	Fish	Vegetables	Poultry		
PRO	00:30 min	00:02 min - 15:00 hours / 1 min	100°C	35-180°C / 5°C					+	+
Steam	00:30 min	00:05 min - 02:00 hours / 5 min	115°C	60-180°C / 5°C	00:35 min	00:25 min	00:30 min	00:40 min	+	+
Baby food	01:00 hour	00:10 min - 12:00 hours / 5 min	100°C	60-180°C / 5°C					+	+
Fry	00:15 min	00:05 min - 02:00 hours / 1 min	155°C	60-180°C / 5°C	00:18 min	00:15 min	00:16 min	00:17 min	-	+
Boil	00:40 min	00:05 min - 08:00 hours / 5 min	110°C	60-180°C / 5°C	01:00 min	00:45 min	00:50 min	01:20 min	+	+
Grain	00:30 min	00:05 min - 04:00 hours / 1 min	100°C	60-180°C / 5°C					+	+
Pilaf	01:00 hour	00:10 min - 02:00 hours / 5 min	110°C	60-180°C / 5°C					+	+
Pasta	00:08 min	00:02 min - 01:00 hour / 1 min	115°C	60-180°C / 5°C					-	+
Milk porridge	00:25 min	00:05 min - 04:00 hours / 1 min	95°C	60-180°C / 5°C					-	+
Cake	00:50 min	00:10 min - 08:00 hours / 5 min	130°C	60-180°C / 5°C					-	+
Bread	03:00 hour	00:10 min - 06:00 hours / 5 min	1 st hour-35°C 2 nd hour-135°C 3 rd hour-135°C	60-180°C / 5°C					-	+

Program	Default cooking time	Cooking time range/increment step	Default cooking temperature	Cooking temperature range/increment step	Product selection/ cooking time				Timer	Auto-heat
					Meat	Fish	Vegetables	Poultry		
Pizza	00:25 min	00:10 min – 01:00 hour / 5 min	120°C	35-180°C / 5°C	-	-	-	-	+	+
Slow cook	05:00 hours	00:10 min – 08:00 hours / 10 min	1 st hour - 100°C 2 nd hour - 95°C 3 rd hour - 90°C	60-180°C / 5°C	-	-	-	-	+	+
Yogurt	08:00 hours	00:10 min – 12:00 hours / 5 min	40°C	35-60°C / 5°C	-	-	-	-	+	-
Soup	01:00 hour	00:10 min – 08:00 hours / 5 min	100°C	60-180°C / 5°C	-	-	-	-	-	+
Game	01:30 hour	00:10 min – 06:00 hours / 5 min	100°C	60-180°C / 5°C	-	-	-	-	+	+
Stew	01:00 hour	00:10 min – 12:00 hours / 5 min	100°C	60-180°C / 5°C	01:00 hour	00:30 min	00:40 min	01:45 min	+	+
Curd	00:20 min	00:05 min – 01:00 hour / 5 min	95°C	60-180°C / 5°C	-	-	-	-	+	+
Dessert	00:40 min	00:10 min – 04:00 hours / 5 min	95°C	60-180°C / 5°C	-	-	-	-	+	+
Deep fry	00:20 min	00:05 min - 01:00 hour / 1 min	180°C	60-180°C / 5°C	01:00 hour	00:30 min	00:40 min	01:45 min	+	+

“PRO” PROGRAM

This program is recommended for cooking various kinds of meat, vegetables, cereals, etc. This cooking program allows you to adjust the cooking time and temperature within a certain range. By default, the cooking time is 30 minutes, but it is possible to manually adjust the time within the 2 minute - 15 hours range with 1-minute increment step as well as the temperature within 35°C - 180°C range with 5°C increment step.

1. To activate this program, repeatedly press the “Menu”  button until the “PRO” program is displayed with light on LCD display.

2. Once the cooking program is selected, it is possible to activate the delayed start function (for reference, see the “Delayed start” section).

3. Press and hold the “Start”  button for 3 seconds to launch the program. The countdown timer will appear on the display. LCD backlight turns red in cooking mode.

4. Once this program is launched, the cooking time can be adjusted as necessary (for information, refer to the “Setting the cooking time” section).

5. Once the cooking program is launched, it is also possible to set the cooking temperature, if necessary (for information, refer to the “Setting the cooking temperature” section).

6. Upon completion of the cooking process, you will hear a beep sound and the appliance will switch to the auto-heat mode. The corresponding indicator and the countdown timer will appear on the display. LCD backlight turns green in auto-heat mode.

7. In order to stop the cooking process, discard the program, or reset the settings, press and hold the

“Cancel”  button for 3 seconds.

“STEAM” PROGRAM

This program is recommended for cooking steamed meals. This cooking program allows you to adjust the cooking time and temperature within a certain range. By default, the cooking time is 30 minutes, but it is possible to manually adjust the time within the 5 minute - 2 hours range with 5-minute increment step as well as the temperature within 60°C - 180°C range with 5°C increment step.

1. To activate this program, repeatedly press the “Menu”  button until the “Steam” program is displayed with light on LCD display.

2. Next, it is necessary to select the cooking product, by repeatedly pressing the “Product selection” button until the required product is displayed on the screen.

3. Once the cooking product is selected, it is possible to activate the delayed start function (for reference, see the “Delayed start” section).

4. Press and hold the “Start”  button for 3 seconds to launch the program. The countdown timer will appear on the display. LCD backlight turns red in cooking mode.

5. Once this program is launched, the cooking time can be adjusted as necessary (for information, refer to the “Setting the cooking time” section).



6. Once the cooking program is launched, it is also possible to set the cooking temperature, if necessary (for information, refer to the “Setting the cooking temperature” section).

7. Upon completion of the cooking process, you will hear a beep sound and the appliance will switch to the auto-heat mode. The corresponding indicator and the countdown timer will appear on the display. Backlight turns green in auto-heat mode.

8. In order to stop the cooking process, discard the program, or reset the settings, press and hold the “Cancel”  button for 3 seconds.

“BABY FOOD” PROGRAM

This program is recommended for cooking different types of baby food. This cooking program allows you to adjust the cooking time and temperature within a certain range. By default, the cooking time is 1 hour, but it is possible to manually adjust the time within the 10 minute - 12 hours range with 5-minute increment step as well as the temperature within 60°C - 180°C range with 5°C increment step.

1. To activate this program, repeatedly press the “Menu”  button until the “Baby food” program is displayed with light on LCD display.
2. Once the cooking program is selected, it is possible to activate the delayed start function (for reference, see the “Delayed start” section).
3. Press and hold the “Start”  button for 3 seconds to launch the program. The countdown timer will appear on the display. LCD backlight turns red in cooking mode.
4. Once this program is launched, the cooking time can be adjusted as necessary (for information, refer to the “Setting the cooking time” section).
5. Once the cooking program is launched, it is also possible to set the cooking temperature, if necessary (for information, refer to the “Setting the cooking temperature” section).
6. Upon completion of the cooking process, you will hear a beep sound and the appliance will switch to the auto-heat mode. The corresponding indicator and the countdown timer will appear on the display. LCD backlight turns green in auto-heat mode.
7. In order to stop the cooking process, discard the program, or reset the settings, press and hold the “Cancel”  button for 3 seconds.

“FRY” PROGRAM

This program is recommended for frying vegetables, meat, poultry, and seafood. This cooking program allows you to adjust the cooking time and temperature within a certain range. By default, the cooking time is 15 minutes, but it is possible to manually adjust the time within the 5 minute - 2 hours range with 1-minute increment step as well as the temperature within 60°C - 180°C range with 5°C increment step.

With this program activated, it is recommended to do the following:

- Cook with an open lid
- Add vegetable oil

The “**Timer**” function in this program is unavailable.

1. To activate this program, repeatedly press the “**Menu**”  button until the “**Fry**” program is displayed with light on LCD display.

2. Next, it is necessary to select the cooking product, by repeatedly pressing the “**Product selection**”



button until the required product is displayed on the screen.

3. Press and hold the “**Start**”  button for 3 seconds to launch the program. The countdown timer will appear on the display. LCD backlight turns red in cooking mode.

4. Once this program is launched, the cooking time can be adjusted as necessary (for information, refer to the “**Setting the cooking time**” section).

5. Once the cooking program is launched, it is also possible to set the cooking temperature, if necessary (for information, refer to the “**Setting the cooking temperature**” section).





6. Upon completion of the cooking process, you will hear a beep sound and the appliance will switch to the auto-heat mode. The corresponding indicator and the countdown timer will appear on the display. Backlight turns green in auto-heat mode.

7. In order to stop the cooking process, discard the program, or reset the settings, press and hold the

“**Cancel**”  button for 3 seconds.

“BOIL” PROGRAM

This program is recommended for cooking / boiling vegetables, meat, poultry, seafood, beans, pastry and other meals. This cooking program allows you to adjust the cooking time and temperature within a certain range. By default, the cooking time is 40 minutes, but it is possible to manually adjust the time within the 5 minute - 8 hours range with 5-minute increment step as well as the temperature within 60°C - 180°C range with 5°C increment step.

1. To activate this program, repeatedly press the “Menu”  button until the “Boil” program is displayed with light on LCD display.
2. Next, it is necessary to select the cooking product, by repeatedly pressing the “Product selection”  button until the required product is displayed on the screen.
3. Once the cooking product is selected, it is possible to activate the delayed start function (for reference, see the “Delayed start” section).
4. Press and hold the “Start”  button for 3 seconds to launch the program. The countdown timer will appear on the display. LCD backlight turns red in cooking mode.
5. Once this program is launched, the cooking time can be adjusted as necessary (for information, refer to the “Setting the cooking time” section).
6. Once the cooking program is launched, it is also possible to set the cooking temperature, if necessary (for information, refer to the “Setting the cooking temperature” section).
7. Upon completion of the cooking process, you will hear a beep sound and the appliance will switch to the auto-heat mode. The corresponding indicator and the countdown timer will appear on the display. Backlight turns green in auto-heat mode.
8. In order to stop the cooking process, discard the program, or reset the settings, press and hold the “Cancel”  button for 3 seconds.

“GRAIN” PROGRAM

This program is recommended for cooking rice, porridge and kids menu from different grains. This cooking program allows you to adjust the cooking time and temperature within a certain range. By default, the cooking time is 30 minutes, but it is possible to manually adjust the time within the 5 minute - 4 hours range with 1-minute increment step as well as the temperature within 60°C - 180°C range with 5°C increment step.

1. To activate this program, repeatedly press the “Menu”  button until the “Grain” program is displayed with light on LCD display.

2. Once the cooking program is selected, it is possible to activate the delayed start function (for reference, see the “Delayed start” section).

3. Press and hold the “Start”  button for 3 seconds to launch the program. The countdown timer will appear on the display. LCD backlight turns red in cooking mode.

4. Once this program is launched, the cooking time can be adjusted as necessary (for information, refer to the “Setting the cooking time” section).

5. Once the cooking program is launched, it is also possible to set the cooking temperature, if necessary (for information, refer to the “Setting the cooking temperature” section).



6. Upon completion of the cooking process, you will hear a beep sound and the appliance will switch to the auto-heat mode. The corresponding indicator and the countdown timer will appear on the display. LCD backlight turns green in auto-heat mode.

7. In order to stop the cooking process, discard the program, or reset the settings, press and hold the

“Cancel”  button for 3 seconds.

“PILAF” PROGRAM





This program is recommended for cooking various kinds of pilaf. This cooking program allows you to adjust the cooking time and temperature within a certain range. By default, the cooking time is 1 hour, but it is possible to manually adjust the time within the 10 minute - 2 hours range with 5-minute increment step as well as the temperature within 60°C - 180°C range with 5°C increment step.

1. To activate this program, repeatedly press the “Menu”  button until the “Pilaf” program is displayed with light on LCD display.
2. Once the cooking program is selected, it is possible to activate the delayed start function (for reference, see the “Delayed start” section).
3. Press and hold the “Start”  button for 3 seconds to launch the program. The countdown timer will appear on the display. LCD backlight turns red in cooking mode.
4. Once this program is launched, the cooking time can be adjusted as necessary (for information, refer to the “Setting the cooking time” section).
5. Once the cooking program is launched, it is also possible to set the cooking temperature, if necessary (for information, refer to the “Setting the cooking temperature” section).
6. Upon completion of the cooking process, you will hear a beep sound and the appliance will switch to the auto-heat mode. The corresponding indicator and the countdown timer will appear on the display. LCD backlight turns green in auto-heat mode.
7. In order to stop the cooking process, discard the program, or reset the settings, press and hold the “Cancel”  button for 3 seconds.

“PASTA” PROGRAM

This program is recommended for cooking pasta. This cooking program allows you to adjust the cooking time and temperature within a certain range. By default, the cooking time is 8 minutes, but it is possible to manually adjust the time within the 2 minute - 1 hour range with 1-minute increment step as well as the temperature within 60°C - 180°C range with 5°C increment step. Upon the audio signal, lay the products into the multicooker. The sound will beep 5 times every 30 seconds and will switch off in 5 minutes, should the products not be laid into the multicooker.

“Timer” function in this program is unavailable.

1. To activate this program, repeatedly press the “Menu”  button until the “Pasta” program is displayed with light on LCD display.
2. Press and hold the “Start”  button for 3 seconds to launch the program. The countdown timer will appear on the display. LCD backlight turns red in cooking mode.
3. Once this program is launched, the cooking time can be adjusted as necessary (for information, refer to the “Setting the cooking time” section).
4. Once the cooking program is launched, it is also possible to set the cooking temperature, if necessary (for information, refer to the “Setting the cooking temperature” section).
5. Once the pasta is laid into the multicooker, press the “Start”  button again.
6. Upon completion of the cooking process, you will hear a beep sound and the appliance will switch to the auto-heat mode. The corresponding indicator and the countdown timer will appear on the display. LCD backlight turns green in auto-heat mode.
7. In order to stop the cooking process, discard the program, or reset the settings, press and hold the “Cancel”  button for 3 seconds.

“MILK PORRIDGE” PROGRAM

This program is recommended for cooking milk cereals, marmalades, jam, fruit jellies and a wide variety of desserts. This cooking program allows you to adjust the cooking time and temperature within a certain range. By default, the cooking time is 25 minutes, but it is possible to manually adjust the time within the 5 minute - 4 hours range with 1-minute increment step as well as the temperature within 60°C - 180°C range with 5°C increment step.

1. To activate this program, repeatedly press the “Menu”



button until the “Milk porridge” program is displayed with light on LCD display.

2. Once the cooking program is selected, it is possible to activate the delayed start function (for reference, see the “Delayed start” section).

3. Press and hold the “Start”



button for 3 seconds to launch the program. The countdown timer

will appear on the display. LCD backlight turns red in cooking mode.

4. Once this program is launched, the cooking time can be adjusted as necessary (for information, refer to the “Setting the cooking time” section).

5. Once the cooking program is launched, it is also possible to set the cooking temperature, if necessary (for information, refer to the “Setting the cooking temperature” section).

6. Upon completion of the cooking process, you will hear a beep sound and the appliance will switch to the auto-heat mode. The corresponding indicator and the countdown timer will appear on the display. LCD backlight turns green in auto-heat mode.

7. In order to stop the cooking process, discard the program, or reset the settings, press and hold the



“Cancel”



button for 3 seconds.



“CAKE” PROGRAM

This program is recommended for baking biscuits, casseroles, pies. This cooking program allows you to adjust the cooking time and temperature within a certain range. By default, the cooking time is 50 minutes, but it is possible to manually adjust the time within the 10 minute - 8 hours range with 5-minute increment step as well as the temperature within 60°C - 180°C range with 5°C increment step.

1. To activate this program, repeatedly press the “Menu”  button until the “Cake” program is displayed with light on LCD display.
2. Once the cooking program is selected, it is possible to activate the delayed start function (for reference, see the “Delayed start” section).
3. Press and hold the “Start”  button for 3 seconds to launch the program. The countdown timer will appear on the display. LCD backlight turns red in cooking mode.
4. Once this program is launched, the cooking time can be adjusted as necessary (for information, refer to the “Setting the cooking time” section).
5. Once the cooking program is launched, it is also possible to set the cooking temperature, if necessary (for information, refer to the “Setting the cooking temperature” section).
6. Upon completion of the cooking process, you will hear a beep sound and the appliance will switch to the auto-heat mode. The corresponding indicator and the countdown timer will appear on the display. LCD backlight turns green in auto-heat mode.
7. In order to stop the cooking process, discard the program, or reset the settings, press and hold the “Cancel”  button for 3 seconds.

“BREAD” PROGRAM

This program is recommended for baking a variety of breads. This cooking program allows you to adjust the cooking time and temperature within a certain range. By default, the cooking time is 3 hours, but it is possible to manually adjust the time within the 10 minute - 6 hours range with 5-minute increment step as well as the temperature within 60°C - 180°C range with 5°C increment step.

1. To activate this program, repeatedly press the “Menu”  button until the “Bread” program is displayed with light on LCD display.
2. Once the cooking program is selected, it is possible to activate the delayed start function (for reference, see the “Delayed start” section).
3. Press and hold the “Start”  button for 3 seconds to launch the program. The countdown timer will appear on the display. LCD backlight turns red in cooking mode.
4. Once this program is launched, the cooking time can be adjusted as necessary (for information, refer to the “Setting the cooking time” section).
5. Once the cooking program is launched, it is also possible to set the cooking temperature, if necessary (for information, refer to the “Setting the cooking temperature” section).
6. Upon completion of the cooking process, you will hear a beep sound and the appliance will switch to the auto-heat mode. The corresponding indicator and the countdown timer will appear on the display. LCD backlight turns green in auto-heat mode.
7. In order to stop the cooking process, discard the program, or reset the settings, press and hold the “Cancel”  button for 3 seconds.

“PIZZA” PROGRAM

This program is recommended for cooking different types of pizza. This cooking program allows you to adjust the cooking time and temperature within a certain range. By default, the cooking time is 25 minutes, but it is possible to manually adjust the time within the 10 minute - 1 hour range with 5-minute increment step as well as the temperature within 60°C - 180°C range with 5°C increment step.

1. To activate this program, repeatedly press the “Menu”  button until the “Pizza” program is displayed with light on LCD display.

2. Once the cooking program is selected, it is possible to activate the delayed start function (for reference, see the “Delayed start” section).

3. Press and hold the “Start”  button for 3 seconds to launch the program. The countdown timer will appear on the display. LCD backlight turns red in cooking mode.

4. Once this program is launched, the cooking time can be adjusted as necessary (for information, refer to the “Setting the cooking time” section).

5. Once the cooking program is launched, it is also possible to set the cooking temperature, if necessary (for information, refer to the “Setting the cooking temperature” section).



6. Upon completion of the cooking process, you will hear a beep sound and the appliance will switch to the auto-heat mode. The corresponding indicator and the countdown timer will appear on the display. LCD backlight turns green in auto-heat mode.

7. In order to stop the cooking process, discard the program, or reset the settings, press and hold the

“Cancel”  button for 3 seconds.



“SLOW COOK” PROGRAM

This program is recommended for cooking corned beef, melted milk, longing all kinds of meat, vegetables, beans, making soups, crumbly porridges, aspic, etc. This cooking program allows you to adjust the cooking time and temperature within a certain range. By default, the cooking time is 5 hours, but it is possible to manually adjust the time within the 10 minute - 8 hours range with 10-minute increment step as well as the temperature within 60°C - 180°C range with 5°C increment step.

1. To activate this program, repeatedly press the “Menu”  button until the “Slow cook” program is displayed with light on LCD display.
2. Once the cooking program is selected, it is possible to activate the delayed start function (for reference, see the “Delayed start” section).
3. Press and hold the “Start”  button for 3 seconds to launch the program. The countdown timer will appear on the display. LCD backlight turns red in cooking mode.
4. Once this program is launched, the cooking time can be adjusted as necessary (for information, refer to the “Setting the cooking time” section).
5. Once the cooking program is launched, it is also possible to set the cooking temperature, if necessary (for information, refer to the “Setting the cooking temperature” section).
6. Upon completion of the cooking process, you will hear a beep sound and the appliance will switch to the auto-heat mode. The corresponding indicator and the countdown timer will appear on the display. LCD backlight turns green in auto-heat mode.
7. In order to stop the cooking process, discard the program, or reset the settings, press and hold the “Cancel”  button for 3 seconds.



“YOGURT” PROGRAM

This program is recommended for making yogurt. This cooking program allows you to adjust the cooking time and temperature within a certain range. By default, the cooking time is 8 hours, but it is possible to manually adjust the time within the 10 minute - 12 hours range with 5-minute increment step as well as the temperature within 35°C - 60°C range with 5°C increment step.

1. To activate this program, repeatedly press the “Menu”  button until the “Yogurt” program is displayed with light on LCD display.
2. Once the cooking program is selected, it is possible to activate the delayed start function (for reference, see the “Delayed start” section).
3. Press and hold the “Start”  button for 3 seconds to launch the program. The countdown timer will appear on the display. LCD backlight turns red in cooking mode.
4. Once this program is launched, the cooking time can be adjusted as necessary (for information, refer to the “Setting the cooking time” section).
5. Once the cooking program is launched, it is also possible to set the cooking temperature, if necessary (for information, refer to the “Setting the cooking temperature” section).
6. An audible tone will sound to indicate the end of the cooking process.
7. In order to stop the cooking process, discard the program, or reset the settings, press and hold the “Cancel”  button for 3 seconds.

“SOUP” PROGRAM

This program is recommended for cooking a variety of soups, compote and marinades. This cooking program allows you to adjust the cooking time and temperature within a certain range. By default, the cooking time is 1 hour, but it is possible to manually adjust the time within the 10 minute - 8 hours range with 5-minute increment step as well as the temperature within 60°C - 180°C range with 5°C increment step.

1. To activate this program, repeatedly press the “Menu”  button until the “Soup” program is displayed with light on LCD display.
2. Once the cooking program is selected, it is possible to activate the delayed start function (for reference, see the “Delayed start” section).
3. Press and hold the “Start”  button for 3 seconds to launch the program. The countdown timer will appear on the display. LCD backlight turns red in cooking mode.
4. Once this program is launched, the cooking time can be adjusted as necessary (for information, refer to the “Setting the cooking time” section).
5. Once the cooking program is launched, it is also possible to set the cooking temperature, if necessary (for information, refer to the “Setting the cooking temperature” section).
6. Upon completion of the cooking process, you will hear a beep sound and the appliance will switch to the auto-heat mode. The corresponding indicator and the countdown timer will appear on the display. LCD backlight turns green in auto-heat mode.
7. In order to stop the cooking process, discard the program, or reset the settings, press and hold the “Cancel”  button for 3 seconds.

“GAME” PROGRAM

This program is recommended for cooking poultry food. This cooking program allows you to adjust the cooking time and temperature within a certain range. By default, the cooking time is 1 hour 30 minutes, but it is possible to manually adjust the time within the 10 minute - 6 hours range with 5-minute increment step as well as the temperature within 60°C - 180°C range with 5°C increment step.

1. To activate this program, repeatedly press the “Menu”  button until the “Game” program is displayed with light on LCD display.

2. Once the cooking program is selected, it is possible to activate the delayed start function (for reference, see the “Delayed start” section).

3. Press and hold the “Start”  button for 3 seconds to launch the program. The countdown timer will appear on the display. LCD backlight turns red in cooking mode.

4. Once this program is launched, the cooking time can be adjusted as necessary (for information, refer to the “Setting the cooking time” section).

5. Once the cooking program is launched, it is also possible to set the cooking temperature, if necessary (for information, refer to the “Setting the cooking temperature” section).

6. Upon completion of the cooking process, you will hear a beep sound and the appliance will switch to the auto-heat mode. The corresponding indicator and the countdown timer will appear on the display. LCD backlight turns green in auto-heat mode.

7. In order to stop the cooking process, discard the program, or reset the settings, press and hold the

“Cancel”  button for 3 seconds.

“STEW” PROGRAM

This program is recommended for stewing vegetables, meat, poultry, and seafood. This cooking program allows you to adjust the cooking time and temperature within a certain range. By default, the cooking time is 1 hour, but it is possible to manually adjust the time within the 10 minute - 12 hours range with 5-minute increment step as well as the temperature within 60°C - 180°C range with 5°C increment step.

1. To activate this program, repeatedly press the “**Menu**”  button until the “**Stew**” program is displayed with light on LCD display.

2. Next, it is necessary to select the cooking product, by repeatedly pressing the “**Product selection**”



button until the required product is displayed on the screen.

3. Once the cooking product is selected, it is possible to activate the delayed start function (for reference, see the “**Delayed start**” section).

4. Press and hold the “**Start**”  button for 3 seconds to launch the program. The countdown timer will appear on the display. LCD backlight turns red in cooking mode.

5. Once this program is launched, the cooking time can be adjusted as necessary (for information, refer to the “**Setting the cooking time**” section).

6. Once the cooking program is launched, it is also possible to set the cooking temperature, if necessary (for information, refer to the “**Setting the cooking temperature**” section).



7. Upon completion of the cooking process, you will hear a beep sound and the appliance will switch to the auto-heat mode. The corresponding indicator and the countdown timer will appear on the display. Backlight turns green in auto-heat mode.

8. In order to stop the cooking process, discard the program, or reset the settings, press and hold

the “**Cancel**”  button for 3 seconds.

“CURD” PROGRAM

This program is recommended for preparing curd, cottage cheese. This cooking program allows you to adjust the cooking time and temperature within a certain range. By default, the cooking time is 20 minutes, but it is possible to manually adjust the time within the 5 minute - 1 hour range with 5-minute increment step as well as the temperature within 60°C - 180°C range with 5°C increment step.

1. To activate this program, repeatedly press the “Menu”  button until the “Curd” program is displayed with light on LCD display.
2. Once the cooking program is selected, it is possible to activate the delayed start function (for reference, see the “Delayed start” section).
3. Press and hold the “Start”  button for 3 seconds to launch the program. The countdown timer will appear on the display. LCD backlight turns red in cooking mode.
4. Once this program is launched, the cooking time can be adjusted as necessary (for information, refer to the “Setting the cooking time” section).
5. Once the cooking program is launched, it is also possible to set the cooking temperature, if necessary (for information, refer to the “Setting the cooking temperature” section).
6. Upon completion of the cooking process, you will hear a beep sound and the appliance will switch to the auto-heat mode. The corresponding indicator and the countdown timer will appear on the display. LCD backlight turns green in auto-heat mode.
7. In order to stop the cooking process, discard the program, or reset the settings, press and hold the “Cancel”  button for 3 seconds.

“DESSERT” PROGRAM

This program is recommended for cooking jams, fruit jellies, and various desserts. This cooking program allows you to adjust the cooking time and temperature within a certain range. By default, the cooking time is 40 minutes, but it is possible to manually adjust the time within the 10 minute - 4 hours range with 5-minute increment step as well as the temperature within 60°C - 180°C range with 5°C increment step.

1. To activate this program, repeatedly press the “Menu”  button until the “Dessert” program is displayed with light on LCD display.

2. Once the cooking program is selected, it is possible to activate the delayed start function (for reference, see the “Delayed start” section).

3. Press and hold the “Start”  button for 3 seconds to launch the program. The countdown timer will appear on the display. LCD backlight turns red in cooking mode.

4. Once this program is launched, the cooking time can be adjusted as necessary (for information, refer to the “Setting the cooking time” section).

5. Once the cooking program is launched, it is also possible to set the cooking temperature, if necessary (for information, refer to the “Setting the cooking temperature” section).

6. Upon completion of the cooking process, you will hear a beep sound and the appliance will switch to the auto-heat mode. The corresponding indicator and the countdown timer will appear on the display. LCD backlight turns green in auto-heat mode.

7. In order to stop the cooking process, discard the program, or reset the settings, press and hold the “Cancel”  button for 3 seconds.





“DEEP FRY” PROGRAM

This program is recommended for deep frying vegetables, meat, poultry, and seafood. This cooking program allows you to adjust the cooking time and temperature within a certain range. By default, the cooking time is 20 minutes, but it is possible to manually adjust the time within the 5 minute - 1 hour range with 1-minute increment step as well as the temperature within 60°C - 180°C range with 5°C increment step.

With this program activated, it is recommended to do the following:

- Cook with an open lid
- Add vegetable oil

The “Timer” function in this program is unavailable.

1. To activate this program, repeatedly press the “Menu”  button until the “Deep fry” program is displayed with light on LCD display.
2. Next, it is necessary to select the cooking product, by repeatedly pressing the “Product selection”  button until the required product is displayed on the screen.
3. Press and hold the “Start”  button for 3 seconds to launch the program. The countdown timer will appear on the display. LCD backlight turns red in cooking mode.
4. Once this program is launched, the cooking time can be adjusted as necessary (for information, refer to the “Setting the cooking time” section).
5. Once the cooking program is launched, it is also possible to set the cooking temperature, if necessary (for information, refer to the “Setting the cooking temperature” section).
6. Upon completion of the cooking process, you will hear a beep sound and the appliance will switch to the auto-heat mode. The corresponding indicator and the countdown timer will appear on the display. Backlight turns green in auto-heat mode.
7. In order to stop the cooking process, discard the program, or reset the settings, press and hold the “Cancel”  button for 3 seconds.

ADDITIONAL FEATURES

STERILIZATION

With the birth of a baby in the family, it is important to take care of his health, because the newborns are very susceptible to various infections. Therefore, from your baby's first day of life it is essential to monitor the cleanliness. The necessary procedures include the sterilization of all the feeding accessories.

Apart from that, jar sterilization comes in handy for housewives canning for the winter.

By using the MC-X170 multicooker, you are able to sterilize bottles and various small items.

Press the **"Sterilization"**  button to activate this mode and you will see the corresponding

indicator appearing on the display  By default, the time is set to 20 minutes with a temperature of 150°C.

MULTICOOKER MAINTENANCE

HANDLING AND CARE INSTRUCTIONS.

Before cleaning the appliance, make sure it is unplugged and completely cooled off. Use a soft cloth and non-abrasive detergent to clean the accessories. We recommend cleaning the appliance immediately after each use.

Before first use, and to remove odors after each cooking, we recommend processing/boiling half of a lemon for **15 minutes** in the “**Steam**” program.

DO NOT use a sponge with hard or abrasive coating, abrasive cleaning agents or aggressive liquids such as petrol and acetone.

CLEANING THE BODY OF THE APPLIANCE

Clean the body of the appliance as needed and according to the handling and care instructions. It is recommended to clean the internal aluminum cover after each use.

CLEANING THE BOWL

It is recommended to clean the bowl after each use and in accordance with the handling and care instructions. The use of the dishwasher is acceptable. After cleaning, wipe dry the outer and inner surfaces of the bowl.

CLEANING THE STEAM VALVE

The steam valve is located on the top lid of the appliance. Clean it each time you use the appliance.

- The valve is removed from the outside of the lid.
- Thoroughly flush the valve under the running water; dry and reinstall it.

CONDENSATE REMOVAL

Each time you cook, condensation occurs and it gets collected in the condensation reservoir on the body of the appliance. The reservoir must be cleaned after each use.

- Gently grasp the sidewall of the reservoir and softly pull it toward you to remove it.
- Pour the condensate and clean the reservoir.
- After cleaning, set the reservoir back in its place.
- Sometimes, excess condensate can accumulate in a special recess on the body of the appliance. Use a kitchen towel or napkin to remove it.

BEFORE APPLYING TO THE SERVICE CENTER

Error code	Possible malfunction	Solution
E1-E5	System error (possible failure of the circuit board or the heating element), the lid is not tightly sealed or automatic overheat protection is activated	Do not switch on the appliance with the empty bowl! Unplug the appliance from the socket and let it cool off for 10-15 minutes. Afterwards, pour some water (broth) into the bowl and resume cooking. Seal the lid tightly. If the problem persists, contact the authorized service center.

Malfunction	Cause	Solution
Unable to switch on the appliance	The multicooker is disconnected from the power source	1) Check the availability of electricity 2) Check whether the multicooker is correctly plugged into a wall socket
Raw dish or it takes too long to cook	1) Cooking time is too short 2) Foreign object between a bowl and the heating element 3) Misplaced cooking bowl 4) Heating element malfunction	1) Extend the cooking time 2) Unplug the appliance, let it cool off and remove the foreign object 3) Properly place the bowl 4) Contact Authorized Service Centre
Auto-heat not working	Heat maintenance elements malfunction	Contact Authorized Service Centre
Tingling electric shock when touching the body of the appliance	Electricity leakage	1) Please connect multicooker to the grounded electricity socket, to prevent damage on product and electric shock, fire. 2) Contact Authorized Service Centre

The recommendations provided above are based on the assessment and analysis of the most common operation problems.

For safety reasons, do not disassemble or repair the appliance on your own. If the problem persists, contact Authorized Service Centre.

WARRANTY TERMS

This product is subject to 3 years warranty from the date of purchase. During this warranty period, the manufacturer is obliged to provide the warranty coverage at Authorized Service Centers by seeking to repair the hardware, replace the defected parts, or replace the product itself. This warranty is valid only if the seal of the shop, together with the signature of the salesperson in the warranty book, confirm the original date of purchase. This warranty is recognized only if the product was used in strict compliance with the instructions outlined in the User Manual, not repaired or disassembled, and not damaged through misuse. It also assumes no missing accessories. The warranty does not cover wear, tear during daily usage of both the appliance and the consumables (filters, bulbs, ceramic and Greblon coating, rubber seals, etc.).



RECKE INDUSTRIES LIMITED
www.myrecke.com